

# 勁佳光電股份有限公司

## VBEST ELECTRONICS LTD.

### Product Specification For LCD Module

(KVPF-7B-002-16)

Model NO. : VGG130607-6FWLWA(LF)

REVISION : 1

■ APPROVAL FOR SPECIFICATIONS ONLY

CUSTOMER :

DCJ

APPROVED BY :

### VBEST LCM R&D CENTER

APPROVED BY

CHECKED BY

PREPARED BY

*[Signature]*  
4/10

*[Signature]* 4/10  
*[Signature]* 4/10'07

*[Signature]* 4/10.07

孟建利  
4/10'07

DIRECTOR

MANAGER

Mechanism Engineer

Electronic Engineer

勁佳光電股份有限公司總公司  
VBEST ELECTRONICS LTD.  
台北縣中和市建一路 186 號 12 樓  
12F, NO. 186, JIAN 1st RD., CHUNG HO CITY,  
TAIPEI HSIEN, TAIWAN, R.O.C  
TEL : +886 2 8227-2788  
FAX : +886 2 8227-2789

勁佳光電股份有限公司台中分公司  
VBEST ELECTRONICS(T.C) LTD  
台中縣潭子鄉台中加工出口區建國路 19 號  
NO. 19, CHIEN KUO ROAD, T.E.P.Z TANTZE  
427 TAICHUNG HSIEN TAIWAN R.O.C  
TEL : +886 4 2532-8889  
FAX : +886 4 2532-6689

東莞莞城德寶電子廠  
VBEST ELECTRONICS(B.V.I)LTD.  
廣東省東莞市城區東縱大道天寶路 9 號  
NO.9, Tian Bao Rd., Dong Zong St., Dong Guan City  
Guang Dong, China.  
TEL : +86 769 220 5258  
FAX : +86 769 220 7258

勁佳光電(昆山)有限公司  
VBEST ELECTRONICS(KUNSHAN) CO.,LTD.  
江蘇省昆山市玉山鎮高科技工業園城北路 8 號  
NO.8, Chengbei Rd., Hi-Tech Industry Park,  
Yushan Town, Kunshan City, Jiangsu, China.  
TEL : +86 512 5778 7288  
FAX : +86 512 5777 0688

<http://www.vbest.com.tw>

**TABLE OF CONTENTS**

<b>NO</b>	<b>CONTENTS</b>	<b>PAGE</b>
1	COVER	1
2	CONTENTS	2
3	RECORD OF REVISION	3
4	MODULE NUMBERING SYSTEM	4
5	GENERAL SPECIFICATION	5
6	LCM DRAWING	6
7	ABSOLUTE MAXIMUM RATING	7
8	ELECTRO-OPTICAL CHARACTERISTICS	7
9	OPTICAL CHARACTERISTICS	8
10	INTERFACE PIN ASSIGNMENT	10
11	BLOCK DIAGRAM	11
12	RECOMMEND POWER SUPPLY	12
13	BACKLIGHT	13
14	RELIABILITY	14
15	LIFE TIME	14
16	SPECIFICATION OF QUALITY ASSURANCE	15
17	HANDLING PRECAUTION	23
18	PACKING METHOD	25





**MODULE NUMBERING SYSTEM**

**V B C 1216 01 - 1 R T N N A**

Serial No: A~Z

Backlight Color:  
N: Without Backlight;  
A: Amber; B: Blue; G: Green;  
L: Yellow; O: Orange; R: Red;  
W: White; Y: YellowGreen;  
X: Others

Backlight Type:  
N: Without Backlight; E: EL; F: CCFL;  
L: General LED; H: High NTSC LED ;  
R: RGB LED; X: Others

LCD Model:  
T: TN; H: HTN; G: STN Gray, Y: STN Yellow;  
B: STN Blue; W: FSTN Black/White;  
C: CSTN; F: TFT; O: OLED; P: PLED;  
L: LTPS; N: Others

LCD Type:  
R: Reflective/Positive;  
S: Reflective/Negative ;  
F: Transflective/Positive ;  
G: Transflective/Negative ;  
U: Transmissive/Positive ;  
T: Transmissive/Negative ; N: Others

Temperature Range & View Direction:  
General Purpose : 1:6H 2:12H 3:3H 4:9H 5:Others  
High Performance: 6:6H 7:12H 8:3H 9:9H 0:Others

STD Product Serial No.: 01~99  
Customer Made Serial No.: A1,A2... A9,B1,B2... B9,C1..

Display Function:  
Segment Number / Characters Lines / Column and Row Dots  
/ Length \* Width of Other

Display Type:  
C: Character Type; G: Graphic Type; S: Segment Type; O: Other

Package Type:  
B: COB; F: COF; G: COG; H: Heat Seal; S: SMT; T: TAB; O: Others

**GENERAL SPECIFICATION**

<b>ITEM</b>	<b>CONTENTS</b>
Module Size	55.0(W)mm *66.15(H)mm *8.0 (D)mm
Display Format	132 * 64 Dots
View Area	50.0 *30.0mm
Dot Size	0.28mm *0.35mm
Dot Pitch	0.31mm *0.39mm
LCD Type	FSTN / Transflective / Positive
View Angle	6 O'clock
Controller IC	NT7538H-D
Duty Ratio	1/65 Duty
Bias	1/9 Bias
Backlight Driver type	External Power
DC to DC circuit	Build-in
Approx. Weight	TBD



LCM DRAWING

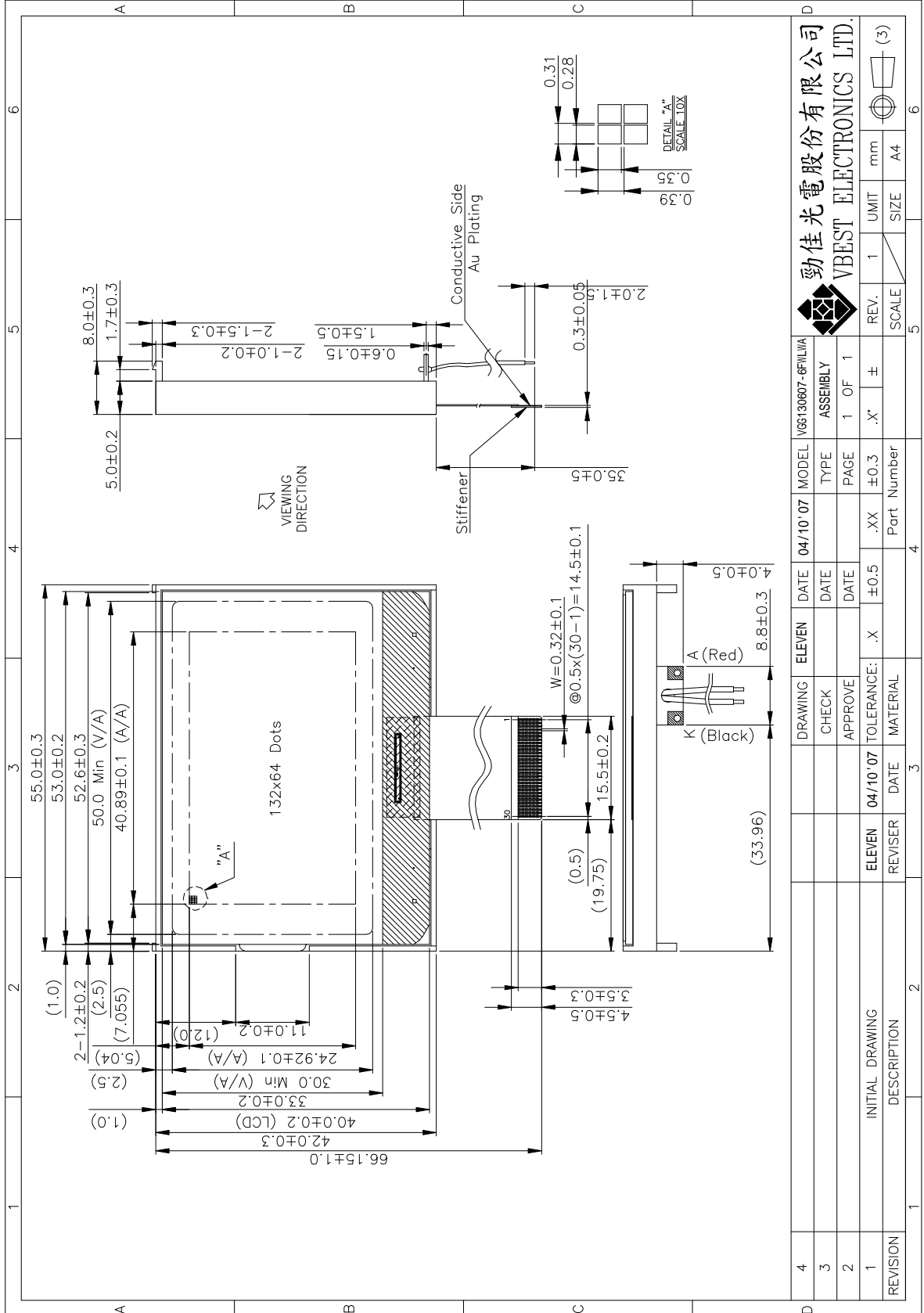

勁佳光電股份有限公司  
VBEST ELECTRONICS LTD.

**ABSOLUTE MAXIMUM RATING(Ta=25 VSS=0V)**

Item	Symbol	Min.	Type	Max.	Unit	Humidity
Power Supply for Logic	$V_{DD}-V_{SS}$	-0.3	--	+4.0	Volt	--
Power Supply for LCD	$V_{LCD}-V_{SS}$	-0.3	--	+15.0	Volt	--
Operating Temperature	Top	-20	--	+70		Note1
Storage Temperature	Tst	-30	--	+80		Note2

Note1: Background color changes slightly depending on ambient temperature. This phenomenon is reversible.

Ta 70 : 75%RH max

Ta>70 : absolute humidity must be lower than the humidity of 75%RH at 80

Note2: Ta at -30 will be <48hrs, at 80 will be <120hrs.

**ELECTRO-OPTICAL CHARACTERISTICS (Ta = 25 )**

Item	Symbol	Condition	Min.	Typ.	Max.	Unit
Power Supply for Logic	$V_{DD}-V_{SS}$	--	--	3.3	--	Volt
Input Voltage	$V_{IL}$	L level	$V_{SS}$	--	$0.2 V_{DD}$	Volt
	$V_{IH}$	H level	$0.8 V_{DD}$	--	$V_{DD}$	
LCD Module Driving Voltage	$V_{LCD}$	$V_{DD}=3.3V$	9.2	9.5	9.8	Volt
Power Supply Current for LCM	$I_{DD}$	$V_{DD}=3.3V$	--	1.0	1.4	mA

**OPTICAL CHARACTERISTICS**

Item	Symbol	Min.	Typ.	Max.	Unit	Condition	Note
Viewing Angle Cr 2	?=0°	1	--	40	--	deg. T=25°C	1.2
	?=180°	2	--	10	--		
	?=90°	3	--	30	--		
	?=270°	4	--	30	--		
Contrast Ratio	Cr	--	7	--	--	T=25°C	3
Response Time (rise)	Tr	--	200	300	ms	T=25°C	4
Response Time (fall)	Tf	--	200	300	ms	T=25°C	4





**Note 1. Definition of angle 1 & 2**

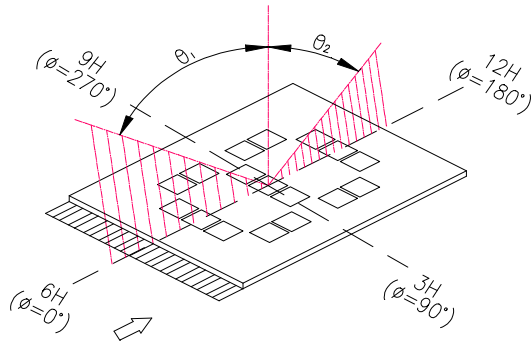

**Note 2. Definition of angle 3 & 4**

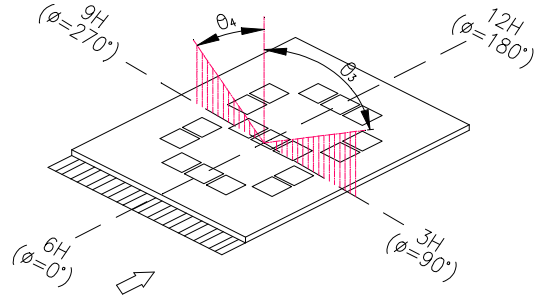

**Note 3. Definition of contrast ratio (Cr)**

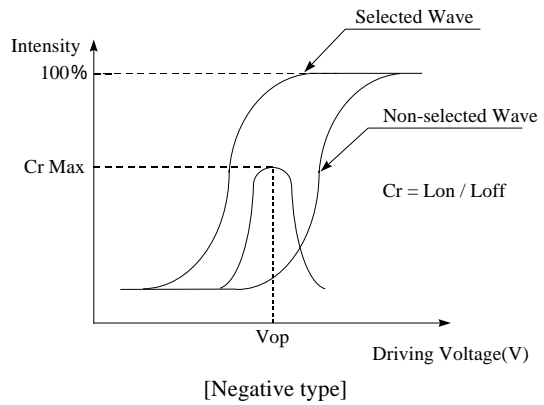
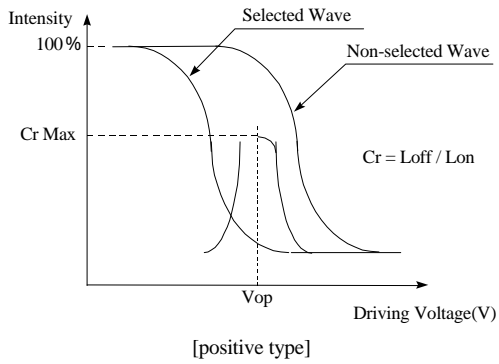

**Note 4. Definition of response time**

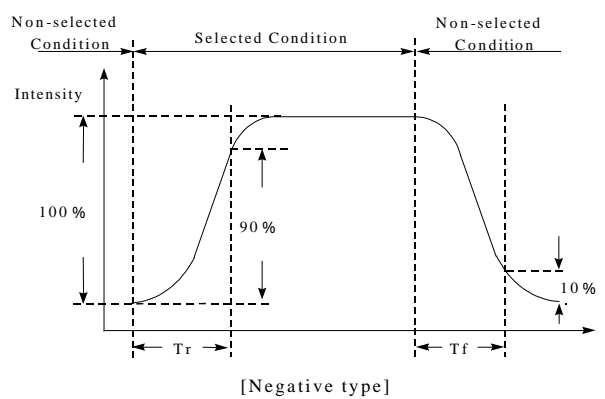
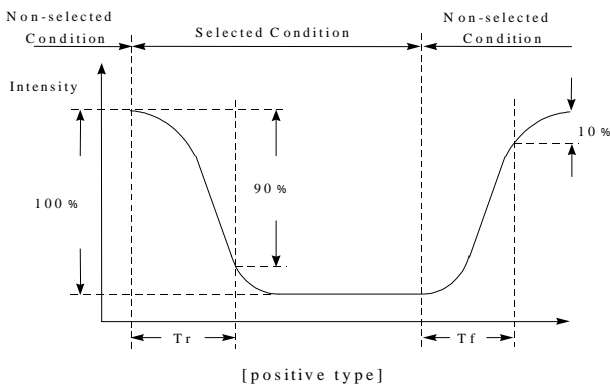

**INTERFACE PIN ASSIGNMENT**

PIN	SYMBOL	FUNCTIONS
1	/CS1	This is the chip select. When /CS1="L" and CS2="H", Then the chip select becomes active data/command I/O is enabled.
2	CS2	
3	/RES	Reset pin.
4	A0	A0="H" : indicate that D0 toD7 are display data. A0="L" : indicate that D0 toD7 are control data.
5	R/W	Read/Write control pin.
6	E	This is used as an enable clock input of the 6800 series.
7	DB0	Data bus
8	DB1	
9	DB2	
10	DB3	
11	DB4	
12	DB5	
13	DB6	
14	DB7	
15	VDD	Power supply
16	VSS	Power supply ( GND )
17	VOUT	DC/DC voltage converter output.
18	CAP3+	Capacitor 3+ pad for Internal DC/DC voltage converter.
19	CAP1-	Capacitor 1- pad for Internal DC/DC voltage converter.
20	CAP1+	Capacitor 1+ pad for Internal DC/DC voltage converter.
21	CAP2+	Capacitor 2+ pad for Internal DC/DC voltage converter.
22	CAP2-	Capacitor 2- pad for Internal DC/DC voltage converter.
23	V1	LCD driver supply voltages. The voltage determined by LCD cell is impedance-converted by a resistive driver or an operation amplifier for application. Voltages should be the following relationship: V0=V1=V2=V3=V4=VSS
24	V2	
25	V3	
26	V4	
27	V0	
28	VR	Voltage adjustment pin.
29	P/S	This is the parallel data input/serial data input switch terminal.
30	IRS	This terminal selects the resistors for the V0 voltage level adjustment.



BLOCK DIAGRAM

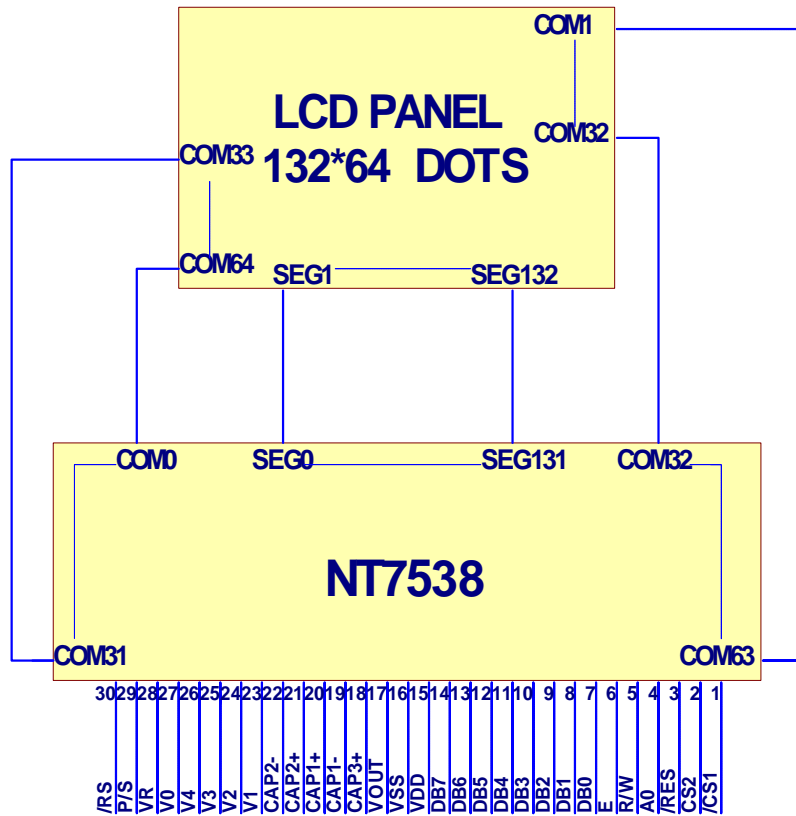

Hardware: C86="H"; 6800 microprocessor bus.

INTRS="H": internal resistor mode.

Software: ADC="L" COM63 to COM0;SEG0 to SEG131



### POWER SUPPLY

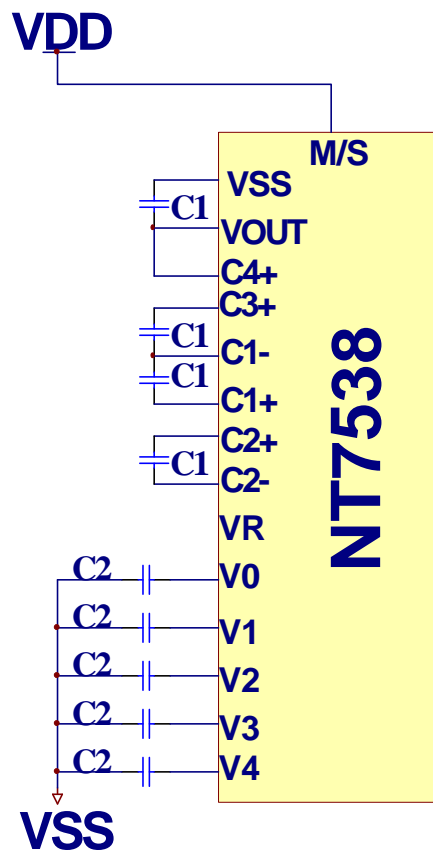

4X Booster

C1:1.0uF~4.7uF/X5R

C2: 0.47uF~1.0Uf/unassigned

While IRS connect to VDD then Ra , Rb should be disconnected and VR=N/C

**BACKLIGHT****1. Standard Lamp Styles (Edge Lighting Type):**

The LED chips are distributed over the edge light area of the illumination unit, which gives the less power consumption:

**2. The Main Advantages of the LED Backlight are as Following:**

2.1 The brightness of the backlight can simply be adjusted.  
By a resistor or a potentiometer.

**3. Data About LED Backlight:**

PARAMETER	Sym.	Min.	Typ.	Max.	Unit	Test Condition	Note
Supply Current	I	-	-	64	mA	V=5.0V	1
Supply Voltage	V	-	5.0	5.2	V	-	1
Reverse Voltage	VR	-	-	5.0	V	-	1
Luminous Intensity (For Module)	IV	100	-	-	Cd/m <sup>2</sup>	IF=64mA	2
Uniformity (For Module)	-	70	-	-	%	IF=64mA	3
Color	White						

**NOTE:**

1. Backlight Only
2. Average Luminous Intensity of P1-P9
3. Uniformity = Min/Max \* 100%

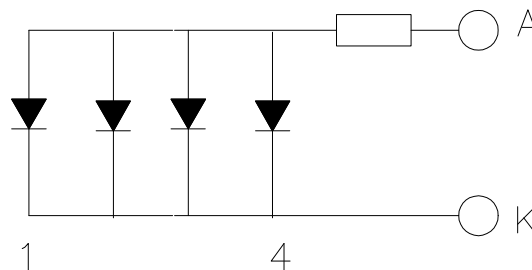
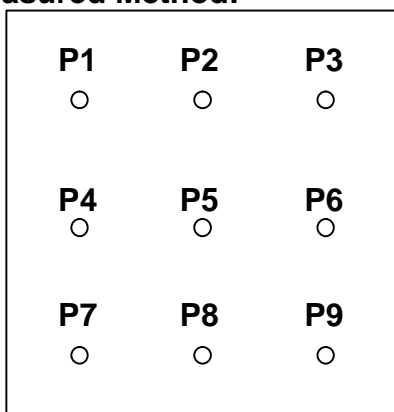
**Measured Method:****(Effective spatial Distribution)**

Hole Diameter $\pm 1\phi$  ; 1 to 9per Position Measured Luminous

**RELIABILITY****Environmental Test**

NO.	Test Item	Test Condition	Test Time	Note
1	Low temperature storage	-30±2	240H	-
2	High temperature storage	80±2	240H	-
3	Low temperature operation	-20±2	240H	-
4	High temperature operation	70±2	240H	-
5	High temperature/ Humidity storage	60±2 90%±5%RH	240H	Without dewing
6	Thermal shock storage	-30 (30min)---25 (5min)--- +80 (30min)	10 cycles	-

**Mechanical Test**

NO.	Test Item	Test Condition	Note
1	Vibration test	Sweep for 1 min at 10Hz , 55Hz , 10Hz , amplitude 1.5mm 15 minutes each in the X , Y and Z directions(Total 45 minutes)	Non operation state
2	Drop test	One angle,three edges and six sides. 75cm above the ground(no weight difference)	Non operation state

**LIFE TIME**

Item	Description
1.	Functions, Performance, appearance, etc. shall be free from remarkable deterioration within 50,000 hours under ordinary operating and storage conditions room temperature (25±10°C) , normal humidity(45±20%RH),and in area not exposed to direct sun light.

**SPECIFICATION OF QUALITY ASSURANCE****1.1 Purpose**

This standard for quality assurance should affirm the quality of LCD module products to supply to **DCJ** ( Purchaser ) by VBEST ELECTRONIC LTD. ( Supplier )

**1.2 Standard for Quality Test**

1.2.1 Test method: According to MIL-STD-105E, General Inspection Level II take a single time.

1.2.2 Electronic Assemblies Standard is according to IPC-AA610 REV. C . CLASS 2

1.2.3 The defects classify of AQL as following list.

Classify	Inspect item	Nonconforming status	AQL	Remark
Critical defect	1.Display damage	( 1 ) Non-Display	AQL=0.65	Product no function
		( 2 ) Occur high current		
		( 3 ) Segment missing		
		( 4 ) LCD with wrong viewing direction		
		( 5 ) Back light unlighted		
	2.Dimension not correct	( 1 ) PCB and bezel out of specification	AQL=0.65	Can not assembly
Major defect	1.Display	( 1 ) Display scanned Disorder	AQL=1.0	
		( 2 ) display defect		
	2.Back-light	( 1 ) Flash , duct		
		( 2 ) Wong color		
Minor defect	1.LCD	( 1 ) Dust ( Black spot , white spot )	AQL=2.50	Appearance defect
		( 2 ) Polarizer scratch		
		( 3 ) Reflective polarizer with bubble		
		( 4 ) Display segment transfigure		
		( 5 ) Color out of the range of sample color		
Total			AQL=2.50	

**1.3 NONCONFORMING ANALYSIS & DEAL WITH MANNERS****1.3.1 Nonconforming analysis:**

- Purchaser should supply the detail data of non-conforming sample and the improper state.
- After accepting the detail data from purchaser , the analysis of Nonconforming should be finished in two weeks.
- If supplier cannot finish analysis on time , must announce purchaser.

**1.3.2 Disposition of nonconforming:**

- If the customer will find any defected product during assembly time , supplier will replace the good product for every defect after.
- Both supplier and customer should analysis the reason and discuss the disposition of nonconforming when the reason of nonconforming is not sure.

**1.4 Agreement items**

Both sides should discuss together when the following problems happen.

- 1.4.1 There is any problem of standard of quality assurance , and both sides Think that must be modified.
- 1.4.2 There is any argument item which does not recorded in the standard of quality assurance.
- 1.4.3 Any other special problem.





## 1.5 Standard of the product appearance test

### 1.5.1 Manner of appearance test

- The test must be under 20W×2 or 40W fluorescent light , and the distance of view must be at 30cm.
- When test the model of transmissive product must add the reflective plate.
- The test direction is base on about 45° of vertical line.

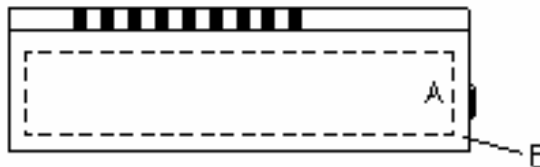
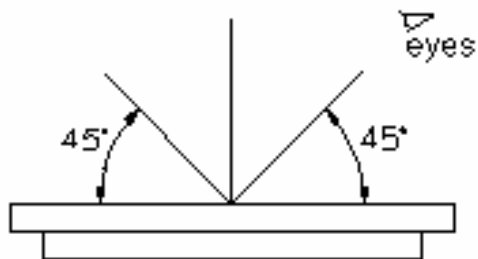

- Definition of area :  
A area : viewing area  
B area : out of viewing area(outside viewing area)

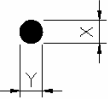
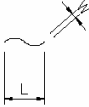

1.5.2 Standard of appearance inspection : ( Unit : mm )

Name:LCM	Inspection Specification																																			
Scope	LCM																																			
Item	Criterion																																			
1.Electronic	<p>(1)Display scanned must be complete.</p> <p>(2)Can not non-display</p> <p>(3)The consumer current can not over the specification</p> <p>(4)Test result as the following must be reject:</p> <p>1.Display incomplete</p> <p>2.Occur high current</p> <p>3.Display defect</p>																																			
2.Black spot , white spot , dust in LCD	<p>(1)Round type : As following drawing</p> $\Psi = (X+Y) / 2$ <div style="display: flex; align-items: center;">  <table border="1" style="margin-left: 20px;"> <thead> <tr> <th>Size</th> <th colspan="2">Acceptable Q'TY</th> </tr> <tr> <th>Area</th> <th>A</th> <th>B</th> </tr> </thead> <tbody> <tr> <td><math>\Psi &lt; 0.1</math></td> <td>Accept no dense</td> <td rowspan="4">Accept No Dense</td> </tr> <tr> <td><math>0.1 &lt; \Psi &lt; 0.2</math></td> <td>2</td> </tr> <tr> <td><math>0.2 &lt; \Psi &lt; 0.25</math></td> <td>1</td> </tr> <tr> <td><math>0.25 &lt; \Psi</math></td> <td>0</td> </tr> </tbody> </table> </div> <p>(2)Line type : (As following drawing)</p> <div style="display: flex; align-items: center;">  <table border="1" style="margin-left: 20px;"> <thead> <tr> <th>Length</th> <th>Width</th> <th colspan="2">Acceptable</th> </tr> <tr> <th colspan="2">Area</th> <th>A</th> <th>B</th> </tr> </thead> <tbody> <tr> <td>Accept</td> <td><math>0.02 \geq L</math></td> <td>Accept no dense</td> <td rowspan="4">Accept No Dense</td> </tr> <tr> <td><math>3.0 \geq L</math></td> <td><math>0.03 \geq L</math></td> <td rowspan="2">2</td> </tr> <tr> <td><math>2.5 \geq L</math></td> <td><math>0.05 \geq L</math></td> </tr> <tr> <td>---</td> <td><math>0.05 \geq L</math></td> <td>As round type</td> </tr> </tbody> </table> </div> <p style="text-align: center;">Total acceptable Q'TY (1) + (2) <math>\leq 3</math></p>	Size	Acceptable Q'TY		Area	A	B	$\Psi < 0.1$	Accept no dense	Accept No Dense	$0.1 < \Psi < 0.2$	2	$0.2 < \Psi < 0.25$	1	$0.25 < \Psi$	0	Length	Width	Acceptable		Area		A	B	Accept	$0.02 \geq L$	Accept no dense	Accept No Dense	$3.0 \geq L$	$0.03 \geq L$	2	$2.5 \geq L$	$0.05 \geq L$	---	$0.05 \geq L$	As round type
Size	Acceptable Q'TY																																			
Area	A	B																																		
$\Psi < 0.1$	Accept no dense	Accept No Dense																																		
$0.1 < \Psi < 0.2$	2																																			
$0.2 < \Psi < 0.25$	1																																			
$0.25 < \Psi$	0																																			
Length	Width	Acceptable																																		
Area		A	B																																	
Accept	$0.02 \geq L$	Accept no dense	Accept No Dense																																	
$3.0 \geq L$	$0.03 \geq L$	2																																		
$2.5 \geq L$	$0.05 \geq L$																																			
---	$0.05 \geq L$	As round type																																		

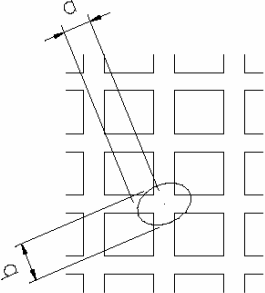

Name:LCM	Inspection Specification												
Scope	LCM												
Item	Criterion												
3.Segmenter transfigure(Digit, word , sign)	<p>c.Alignment layer defect :</p> $\Psi = (a+b) / 2$  <table border="1" data-bbox="571 963 1308 1288"> <thead> <tr> <th>Size <math>\Psi</math></th> <th>Acceptable Q'TY</th> </tr> </thead> <tbody> <tr> <td><math>\Psi \leq 0.4</math></td> <td>Accept no dense</td> </tr> <tr> <td><math>0.4 &lt; \Psi \leq 1.0</math></td> <td>5</td> </tr> <tr> <td><math>1.0 &lt; \Psi \leq 1.5</math></td> <td>3</td> </tr> <tr> <td><math>1.5 &lt; \Psi \leq 2.0</math></td> <td>2</td> </tr> <tr> <td>Total acceptable Q'TY</td> <td>7</td> </tr> </tbody> </table>	Size $\Psi$	Acceptable Q'TY	$\Psi \leq 0.4$	Accept no dense	$0.4 < \Psi \leq 1.0$	5	$1.0 < \Psi \leq 1.5$	3	$1.5 < \Psi \leq 2.0$	2	Total acceptable Q'TY	7
Size $\Psi$	Acceptable Q'TY												
$\Psi \leq 0.4$	Accept no dense												
$0.4 < \Psi \leq 1.0$	5												
$1.0 < \Psi \leq 1.5$	3												
$1.5 < \Psi \leq 2.0$	2												
Total acceptable Q'TY	7												
4.Color	Sample of the lowest acceptable quality level.												
5.Back-light	<p>(1)The color of backlight should correspond its specification.</p> <p>(2)Not allow flash and unlighten on backlight.</p> <p>(3)Not allow larger than 0.25mm dust on backlight.</p>												
6.COB	<p>(1)Not allow the PAD of wire bond exposed.</p> <p>(2)Not allow the line type of wire bond on resin.</p> <p>(3)Not allow bubble and dust on resin.</p>												

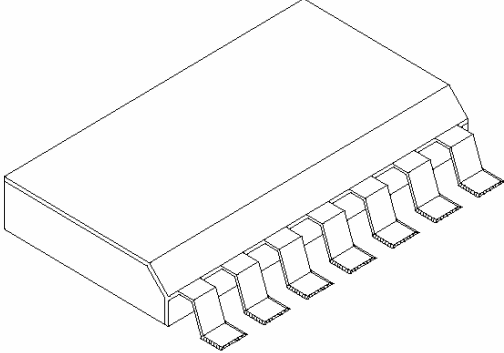

Name:LCM	Inspection Specification
Scope	LCM
Item	Criterion
7.PCB	(1)Not allow dirty and reminded solder on PCB.  (2)Not allow scratch on pin PAD.

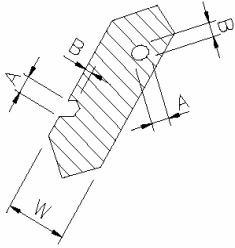

Name:LCM	Inspection Specification																		
Scope	LCM																		
Item	Criterion																		
1.Polarizer scratch	Following the dust specification of time type.																		
2.Polarizer ripple	Not allow get in side Viewing Area .																		
3.Polarizer bubble	<p>(1)Bubble could be seen by eyes exigently to be judged According to black spot specification.</p> <p>(2)Not allow polarize jutting glass outside.</p> <table border="1" style="margin-left: auto; margin-right: auto;"> <thead> <tr> <th>Size</th> <th colspan="2">Acceptable Q'TY</th> </tr> <tr> <th>Area</th> <th>A</th> <th>B</th> </tr> </thead> <tbody> <tr> <td><math>\Psi &lt; 0.2</math></td> <td>Accept no dense</td> <td rowspan="4">Accept No Dense</td> </tr> <tr> <td><math>0.2 &lt; \Psi &lt; 0.5</math></td> <td>3</td> </tr> <tr> <td><math>0.5 &lt; \Psi &lt; 1.0</math></td> <td>2</td> </tr> <tr> <td><math>1.0 &lt; \Psi</math></td> <td>0</td> </tr> <tr> <td colspan="2">Total acceptable Q'TY</td> <td>3</td> </tr> </tbody> </table>	Size	Acceptable Q'TY		Area	A	B	$\Psi < 0.2$	Accept no dense	Accept No Dense	$0.2 < \Psi < 0.5$	3	$0.5 < \Psi < 1.0$	2	$1.0 < \Psi$	0	Total acceptable Q'TY		3
Size	Acceptable Q'TY																		
Area	A	B																	
$\Psi < 0.2$	Accept no dense	Accept No Dense																	
$0.2 < \Psi < 0.5$	3																		
$0.5 < \Psi < 1.0$	2																		
$1.0 < \Psi$	0																		
Total acceptable Q'TY		3																	
4.Segmenter transfigure(Digit, word , sign)	<p>(1)PIN hole , transfigure : (See below)</p> <p>a. Segment display:</p>  <table border="1" style="margin-left: auto; margin-right: auto;"> <thead> <tr> <th>Width</th> <th>Acceptable</th> </tr> </thead> <tbody> <tr> <td><math>W \leq 0.4</math></td> <td><math>\Psi \leq 0.2</math> and <math>\Psi \leq 1/2w</math></td> </tr> <tr> <td><math>W \geq 0.4</math></td> <td><math>\Psi \leq 0.25</math> and <math>\Psi \leq 1/3v</math></td> </tr> </tbody> </table> <p>Note: W : Segment width <math>\Psi</math> : (AB)/2 Only allow one defect in one segment. <math>\Psi</math> under 0.10mm is acceptable.</p>	Width	Acceptable	$W \leq 0.4$	$\Psi \leq 0.2$ and $\Psi \leq 1/2w$	$W \geq 0.4$	$\Psi \leq 0.25$ and $\Psi \leq 1/3v$												
Width	Acceptable																		
$W \leq 0.4$	$\Psi \leq 0.2$ and $\Psi \leq 1/2w$																		
$W \geq 0.4$	$\Psi \leq 0.25$ and $\Psi \leq 1/3v$																		

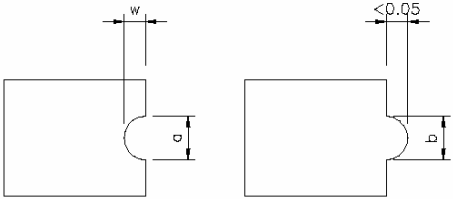
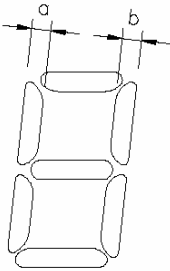
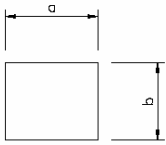

Name:LCM	Inspection Specification														
Scope	LCM														
Item	Criterion														
5.Segmenter transfigure(Digit, word , sign)	<p>b.dot Matrix display:</p>  <table border="1" data-bbox="571 815 1307 1146"> <thead> <tr> <th>Size</th> <th>Acceptable Q'TY</th> </tr> </thead> <tbody> <tr> <td><math>a, b \leq 0.1</math></td> <td>Accept no dense</td> </tr> <tr> <td><math>(a + b) / 2 \leq 0.1</math></td> <td>Accept no dense</td> </tr> <tr> <td><math>0.5 &lt; \Psi &lt; 1.0</math></td> <td>3</td> </tr> <tr> <td>Total acceptable Q'TY</td> <td>7</td> </tr> </tbody> </table> <p>(2)a.Segment are not same width</p>  <table border="1" data-bbox="975 1323 1394 1527"> <tbody> <tr> <td><math>a \geq b</math></td> <td><math>a / b \leq 4 / 3</math></td> </tr> <tr> <td><math>a &lt; b</math></td> <td><math>a / b &gt; 4 / 3</math></td> </tr> </tbody> </table> <p>b.Segment are not equal no length and size within <math>\pm 15\%</math> of production specification.</p> 	Size	Acceptable Q'TY	$a, b \leq 0.1$	Accept no dense	$(a + b) / 2 \leq 0.1$	Accept no dense	$0.5 < \Psi < 1.0$	3	Total acceptable Q'TY	7	$a \geq b$	$a / b \leq 4 / 3$	$a < b$	$a / b > 4 / 3$
Size	Acceptable Q'TY														
$a, b \leq 0.1$	Accept no dense														
$(a + b) / 2 \leq 0.1$	Accept no dense														
$0.5 < \Psi < 1.0$	3														
Total acceptable Q'TY	7														
$a \geq b$	$a / b \leq 4 / 3$														
$a < b$	$a / b > 4 / 3$														

**HANDLING PRECAUTION****1、 Mounting Method**

The panel of the LCD Module consists of two thin glass plates with polarizes which easily get damaged since the Module is fixed by utilizing fitting holes in the printed circuit board. Extreme care should be taken when handling the LCD Modules.

**2、 Caution of LCD handling & cleaning**

When cleaning the display surface, use soft cloth with solvent (recommended below) and Wipe lightly.

- Isopropyl alcohol
- Ethyl alcohol
- Trichlorotrifluoroethane

Do not wipe the display surface with dry or hard materials that will damage the polarize surface.

Do not use the following solvent :

- Water
- Aromatics

**3、 Caution against static charge**

The LCD Module use C-MOSLSI drivers, so we recommend end that you connect any unused input terminal to VDD or VSS, do not input any signals before power is turned on.

And ground your body, Work/assembly table. And assembly equipment to protect against static electricity.

**4、 Packaging**

-Modules use LCD elements, and must be treated as such. Avoid in tense shock and falls from a height.

-To prevent modules from degradation. Do not operate or store them exposed directly to sunshine or high temperature/humidity.

**5、 Caution for operation**

-It is indispensable to drive LCD's with in the specified voltage limit since the higher voltage than the limit shorten LCD life.

An electrochemical reaction due to direct current causes LCD deterioration, Avoid the use of -Response time will be extremely delayed at lower temperature than the operating temperature range and on the other hand at higher temperature LCD's show dark color in them.

However those phenomena do not mean malfunction or out of order with LCD's. Which will come back in the specified operating temperature range.

- If the display area is pushed hard during operation, some font will be abnormally displayed but it resumes normal condition after turning off once.

- A slight dew depositing on terminals is a cause for electro-chemical reaction resulting in terminal open circuit.

Usage under the relative condition of 40 , 50%RH or less is required.



## 6、 Storage

In the case of storing for a long period of time ( for instance. For years )for the purpose or replacement use,

The following ways are recommended.

- Storage in a polyethylene bag with sealed so as not to enter fresh air outside in it, And with no desiccant.
- Placing in a dark place where neither exposure to direct sunlight nor light is. Keeping temperature in
- the specified storage temperature range.
- Storing with no touch on polarizer surface by the anything else. ( It is recommended to store them as they have been contained in the inner container at the time of delivery )

## 7、 Safety

It is recommendable to crash damaged or unnecessary LCD into pieces and wash off liquid crystal by

using solvents such as acetone and ethanol. Which should be burned up later.

When any liquid crystal leaked out of a damaged glass cell comes in contact with your hands, please wash it off well with soap and water.

## 8. Terms of Warrant

### 1. Acceptance inspection period

The period is within one month after the arrival of contracted commodity at the buyer's factory site.

### 2. Applicable warrant period

The period is within twelve months since the date of shipping out under normal using and storage conditions.





PACKING METHOD

Packing Method

CUSTOMER : DCJ

MODEL :VGG130607-6FWLWA

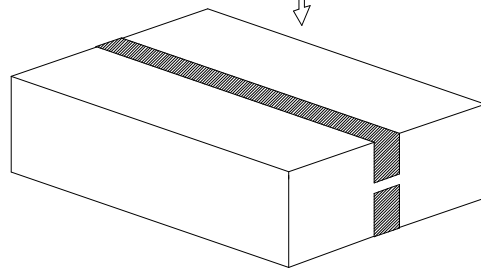
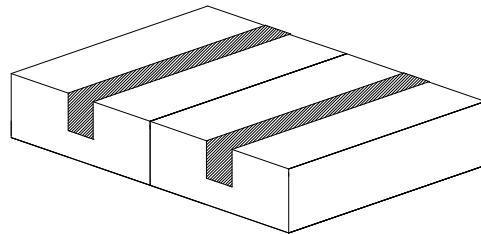
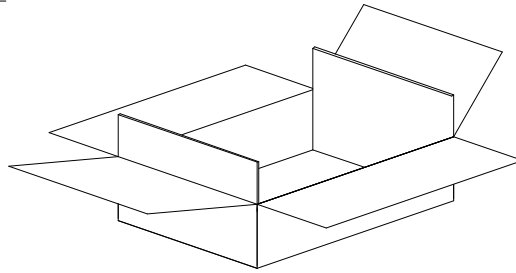
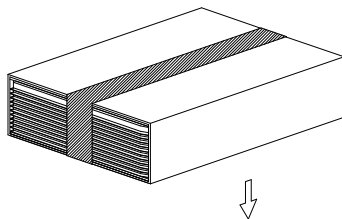
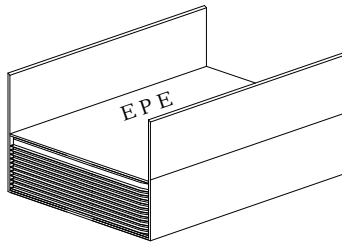
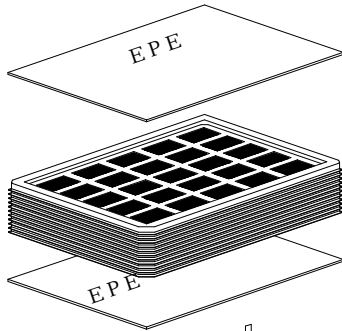

PARTS LIST

	ITEM	SIZE(LxWxH) unit:mm	MATERIAL	Q.T.Y	NOTE
1	TRAY	372.0*262.0	PET	--	
2	CARD BOARD(P1)	925.0*275.0*3.5	CARTON	1	
3	CARD BOARD(P2)	776.0*375.0*3.5	CARTON	2	
4	CARD BOARD(P3)	375.0*265.0*3.5	CARTON	4	
5	INTERNAL BOX(B2)	400.0*290.0*150.0	CARTON	2	
6	EXTERNAL BOX(B1)	600.0*420.0*170.0	CARTON	1	
7	PRODUCT	53.0*65.15*2.8		--	